

PRODUCT FLYER

# PXI Analog I/O

## CONTENTS

[PXI Analog Input Module](#)

[PXI Analog Output Module](#)

[PXI Displacement Input Module](#)

[PXI Strain/Bridge Input Module](#)

[PXI Temperature Input Module](#)

[NI-DAQmx Driver and Application Programming Interface](#)

[Platform-Based Approach to Test and Measurement](#)

[Hardware Services](#)

# PXI Analog Input Module

PXIe-4300, PXIe-4302, PXIe-4303, PXIe-4304, PXIe-4305, PXIe-4309, PXIe-4310, PXIe-4481

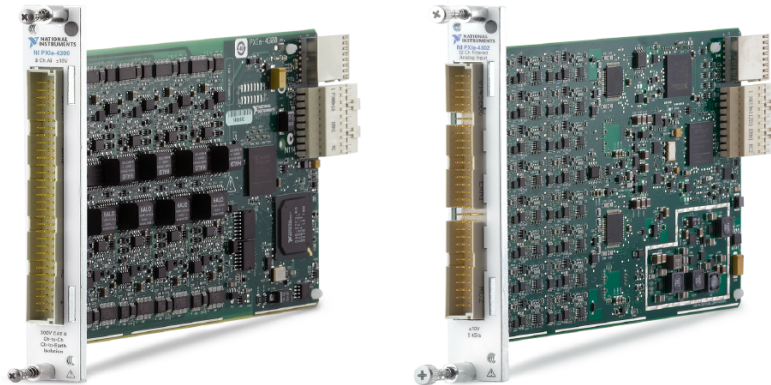

- **Software:** Includes API support for LabVIEW and text-based languages, complete with shipping examples and detailed help files.
- Voltage measurements up to 2 MS/s per channel or 28-bits
- Simultaneous sampling architecture
- Software-selectable input ranges and input channel isolation available
- PXIe bus provides tight synchronization and a modular, expandable platform
- Anti-alias and Low-Pass filtering available

## Modular, High Performance Analog Measurements

PXI Analog Input Modules feature multiple analog-to-digital converters (ADCs) as well as built-in signal conditioning. Sample rates range from 5 kS/s/ch to 2 MS/s/ch. You can choose from modules that offer up to 28 bits of resolution and up to 32 simultaneous channels. PXI Analog Input Modules offer different types of isolation and filtering, so you can choose options that meet specific application needs. The modules promote increased accuracy, high data throughput, and are ideal for scalable measurement systems with low and high channel counts.

Table 1. PXI Analog Input Modules provide high performance measurements on a platform built for modularity, high channel counts, and tight hardware synchronization.

	Max Num Ch.*	Simultaneous	Max Sample Rate	Max Resolution	Max Input Voltage	Anti-Alias Filter	Isolation	Selectable Low-Pass Filter
PXIe-4300	8	Yes	250 kS/s/ch	16 bits	300 V	No	Ch-Ch	10 kHz, 100 kHz
PXIe-4302	32	Yes	5 kS/s/ch	24 bits	10 V	Yes	None	2 Hz, 20 kHz, 200 kHz, 1 Hz
PXIe-4303	32	Yes	51.2 kS/s/ch	24 bits	10 V	Yes	None	2 Hz, 20 kHz, 200 kHz, 1 Hz
PXIe-4304	32	Yes	5 kS/s/ch	24 bits	42 V	Yes	None	2 Hz, 20 kHz, 200 kHz, 1 Hz
PXIe-4305	32	Yes	51.2 kS/s/ch	24 bits	42 V	Yes	None	2 Hz, 20 kHz, 200 kHz, 1 Hz
PXIe-4309	32	Yes	2 MS/s/ch	28 bits	15 V	Yes	None	2 Hz, 20 kHz, 200 kHz, 1 Hz
PXIe-4310	8	Yes	400 kS/s/ch	16 bits	600 V	No	Ch-Ch	10 kHz, 100 kHz
PXIe-4481	6	Yes	20 MS/s/ch	24 bits	10 V	Yes	None	10 kHz, 100 kHz

\*differential channels

## Detailed Views of PXI Analog Input Module

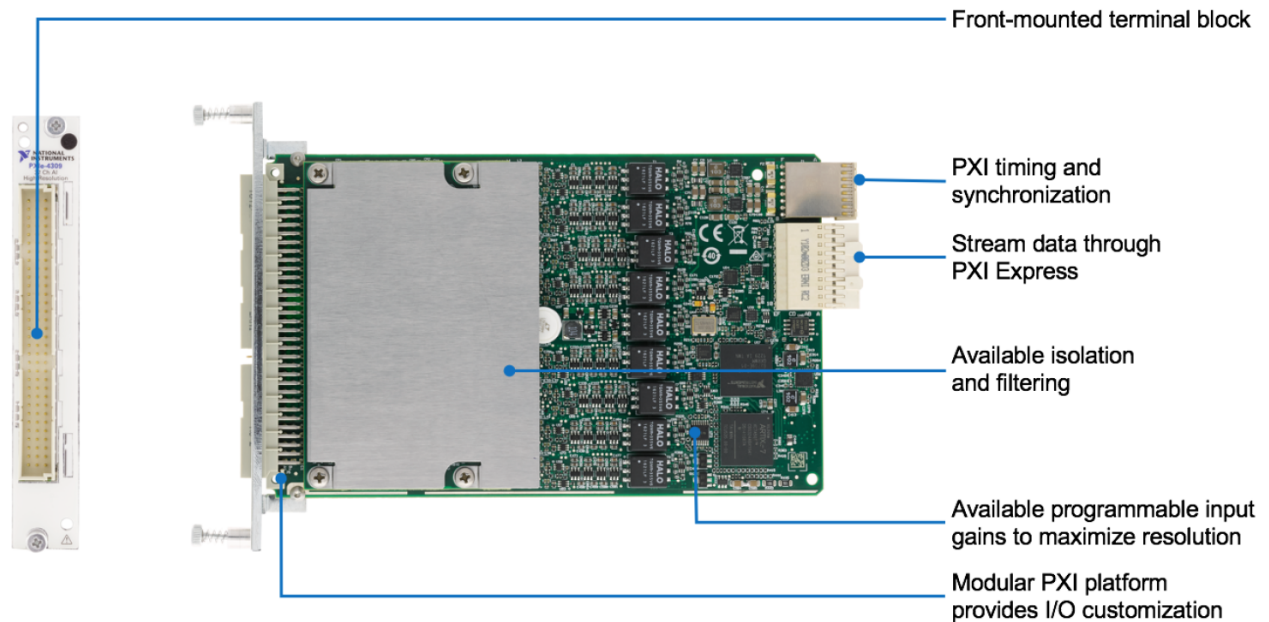

# Key Features

---

## High Accuracy Analog Measurements

NI PXI Analog Input Modules have analog signal paths that have been meticulously designed, tested, and calibrated to ensure the highest possible accuracy is achieved across all input channels. Because of this thorough design-and-test philosophy, NI is able to provide thoroughly documented accuracy specifications to allow a complete understanding of device performance under a range of possible operating conditions. The specifications documentation for each device provides a section dedicated to understanding the calculation of AI absolute accuracy, alongside a wealth of other performance details.

## A Family of Products Built Around Flexibility

Measurement requirements vary significantly from one application to the next, and the modularity of the PXI platform makes custom hardware configuration easy, and the breadth of specification options for PXI Analog Input Modules covers a wide swath of circumstances. Consider the following models for their respective strengths as needed to meet your application demands:

### Highest Bandwidth for Dynamic Signal Analysis – PXIe-4481

You can sample up to 1.25 MS/s per channel in frequency domain mode with bandwidth up to 500 kHz to measure higher bandwidth acoustic transducers, pressure sensors, and hydrophones. With the tradeoff of lower resolution, you can sample up to 20 MS/s per channel to capture a zero to full-scale transition in 1  $\mu$ sec. Ideal for measuring sudden changes such as explosions and high-speed impacts.

### Exceptionally Low Noise Voltage Measurements – PXIe-4309

Capable of delivering an effective 28-bits of resolution, the PXIe-4309 is flexible module that implements features such as autozero or chopping to remove offset error in software as frequently as every sample. This model is capable of delivering less than 100nV of noise for all 32 channels at a 30 sample per second per channel input rate. This combination of low-noise and high channel density makes it ideal for low-level power characterization of board-level products such as consumer electronics.

### Substantial Isolation for High Common-Mode Applications – PXIe-4300|PXIe-4310

At 300V CAT II and 600V CATO isolation levels, the PXIe-4300 and PXIe-4310 are capable of delivering accurate voltage measurements even in the presence of significant common mode voltage levels. These models are ideal for fuel cell or battery stack characterization as well as high current power measurements.

### Channel density with Application-Specific Specifications – PXIe-4302/3/4/5

High per-module channel count, plus the expandable nature of the PXI platform, makes these modules a compelling solution for a variety of voltage measurement configurations when a higher total channel count is required. Multiple sample rate and input range options make selecting the best configuration for optimal accuracy and resolution a manageable task.

## Superior Alias Rejection with Anti-Alias Filtering

A digitizer or ADC might sample signals containing frequency components above the Nyquist limit. The undesirable effect of the digitizer modulating out-of-band components into the Nyquist bandwidth is aliasing. The greatest danger of aliasing is that you cannot determine if aliasing occurred by looking at the ADC output. If an input signal contains several frequency components or harmonics, some of these components might be represented correctly while others contain aliased artifacts.

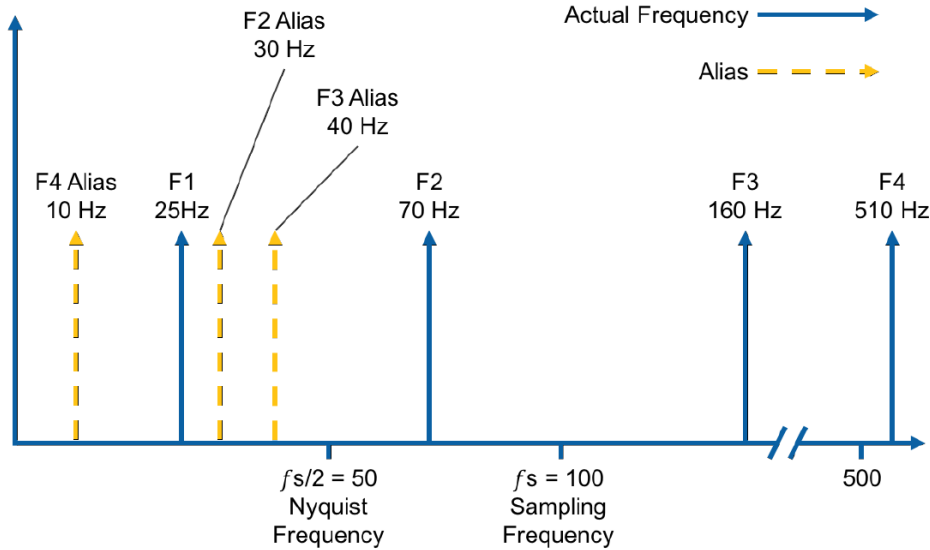
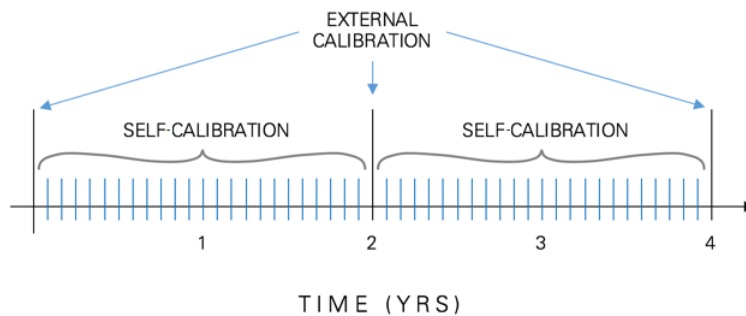

Figure 1. Frequency components above the sampling frequency appear as aliased signals in the frequency band of interest.

Lowpass filtering to eliminate components above the Nyquist frequency either before or during the digitization process can guarantee that the digitized data set is free of aliased components. In buffered mode, the modules employ both digital and analog lowpass filters to achieve this protection.

## Guaranteed Specifications & Calibration Interval

The warranted specifications of all National Instruments data acquisition devices and modules are guaranteed to fall within the published limits for at least a year from factory calibration. Many devices and modules include a high precision on-board reference and a self-calibration feature for intermittent calibrations during use. This technology helps to correct for changes in the performance of the hardware over the normal range of operating conditions, like local changes in temperature. For guaranteed performance over time, external calibration services are provided to return a device to its “factory” performance state. This once again guarantees performance to the published specifications for an additional calibration interval of at least one year.



# PXI Analog Output Module

PXI-6704, PXI-6711, PXI-6713, PXI-6722, PXI-6723, PXI-6733, PXIe-4322, PXIe-6738, PXIe-6739

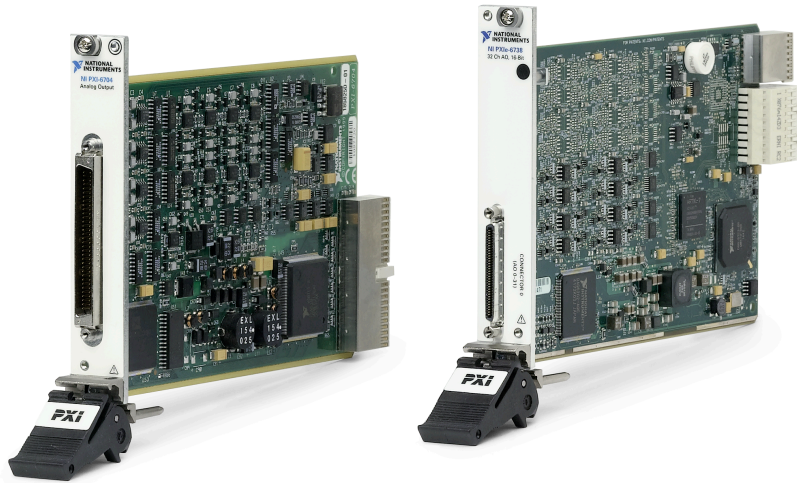

- **Software:** Includes API support for LabVIEW and text-based languages, complete with shipping examples and detailed help files.
- Voltage generation up to 1 MS/s
- Output resolution from 12 to 16 bits
- Output ranges up to 60V, isolation up to 300 Vrms
- PXIe bus provides tight synchronization and a modular, expandable platform

## Modular, High Performance Analog Generation

PXI Analog Output Modules support static, hardware-, and software-timed voltage output applications. Modules also include 5 V TTL/CMOS digital I/O lines. Some PXI Analog Output Modules can deliver simultaneous, multichannel updates for control and waveform output applications, such as stimulus-response, power supply control, high-speed, deterministic control, and sensor/signal simulation. These advanced features enable you to use the PXI Analog Output Module to replace several kinds of instruments, including stand-alone proportional integral derivative (PID) controllers, low-speed arbitrary waveform generators, and function generators.

*Table 1. PXI Analog Input Modules provide high performance measurements on a platform built for modularity, high channel counts, and tight hardware synchronization.*

	Num Ch.	Max Update Rate	Output Range	Resolution	Output Accuracy <sup>1</sup>	Slew Rate	Output Current	Simultaneous	Isolation
PXI-6704	32 <sup>2</sup>	Static	10 V	16 bits	1.07 mV	N/A	20 mA	No	None
PXI-6711	4	1 MS/s/ch	10 V	12 bits	5.95 mV	20 V/μS	5 mA	Yes	None
PXI-6713	8	1 MS/s/ch	10 V	12 bits	5.95 mV	20 V/μS	5 mA	Yes	None
PXI-6722	8	800 kS/s/ch	10 V	13 bits	10.78 mV	0.7 V/μS	5 mA	Yes	None
PXI-6723	32	800 kS/s/ch	10 V	13 bits	10.78 mV	0.7 V/μS	5 mA	Yes	None
PXI-6733	8	1 MS/s/ch	10 V	16 bits	2.24 mV	15 V/μS	5 mA	Yes	None
PXIe-4322	8	250 kS/s/ch	16 V	16 bits	2.08 mV	10 V/μS	20 mA	Yes	300 Vrms Ch-Ch CAT II
PXIe-6738	32 <sup>3</sup>	1 MS/s/ch	10 V	16 bits	2.94 mV	3.0 V/μS	10 mA	Yes	None
PXIe-6739	64 <sup>3</sup>	1 MS/s/ch	10 V	16 bits	2.94 mV	3.0 V/μS	10 mA	Yes	None

<sup>1</sup>Accuracy specifications are typical for the measurement device and do not account for losses due to cables, sensors, etc.

<sup>2</sup>16 voltage source channels, 16 current source channels

<sup>3</sup>Output channels on the PXIe-6738/6739 are grouped into banks of 4 multiplexed channels. Maximum update rate may be lower than 1MS/s/ch at higher channel counts

# Detailed View of PXI Analog Output Module

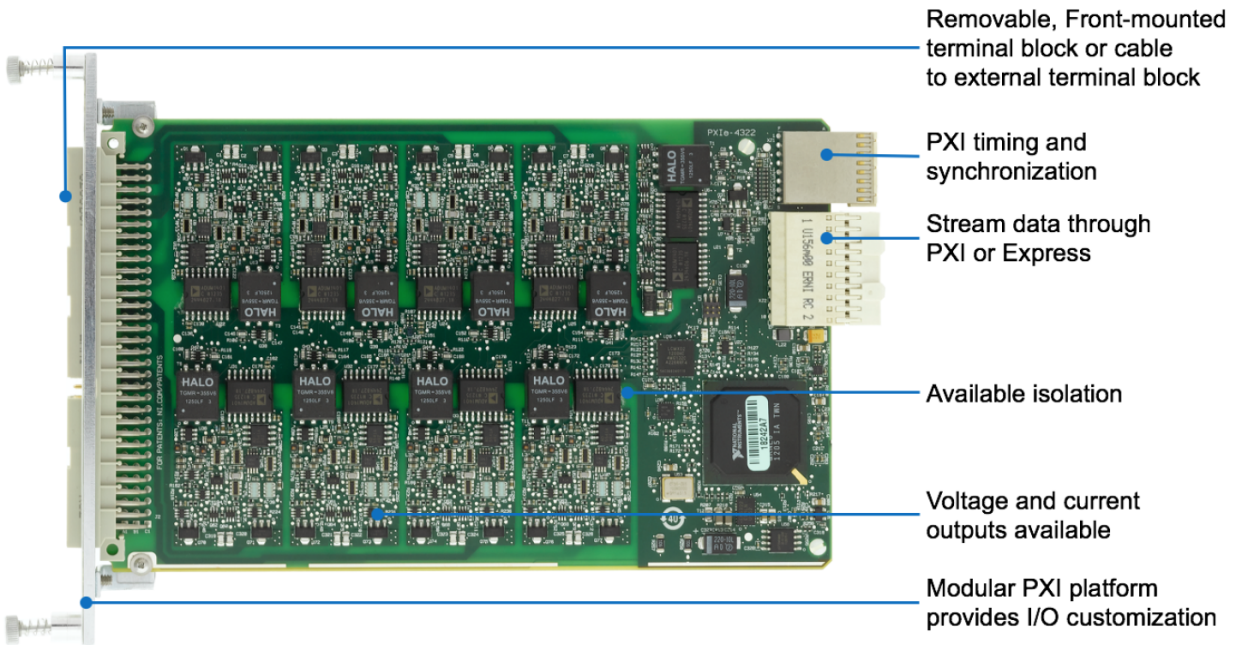



# Key Features

---

## Modular Platform for Scalable Channel Counts

In addition to significant channel density per module, the modularity of the PXI platform means a single PXI chassis can be filled with as many modules as is necessary to achieve the desired channel count in one compact form factor. With a maximum of 17 IO slots a single chassis, you can achieve a single PXI system with up to 1,088 analog output channels. Additionally, PXI chassis can be daisy-chained to add more IO slots to a single system. For high-channel-count control applications, PXI Analog Output Modules provide a powerful mix of performance and channel density, at a competitive price per channel.

## Guaranteed Specifications & Calibration Interval

The warranted specifications of all National Instruments data acquisition devices and modules are guaranteed to fall within the published limits for at least a year from factory calibration. Many devices and modules include a high precision on-board reference and a self-calibration feature for intermittent calibrations during use. This technology helps to correct for changes in the performance of the hardware over the normal range of operating conditions, like local changes in temperature. For guaranteed performance over time, external calibration services are provided to return a device to its “factory” performance state. This once again guarantees performance to the published specifications for an additional calibration interval of at least one year.

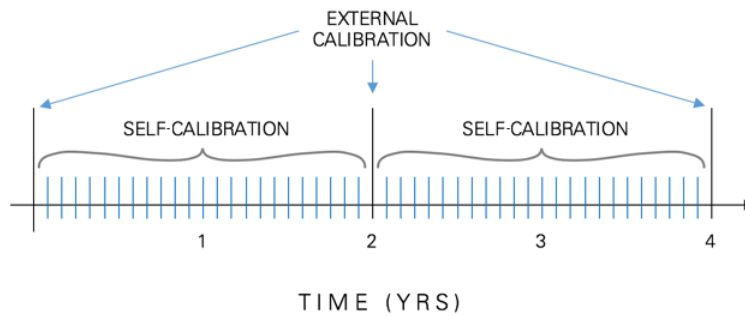

# PXI Displacement Input Module

PXIe-4340



- **Software:** Includes API support for LabVIEW and text-based languages, complete with shipping examples and detailed help files.
- 24-bit AC LVDT, AC RVDT, Resolver, and Synchro Measurements
- Simultaneous sampling architecture
- Sensor excitation from  $1V_{RMS}$ - $7V_{RMS}$  at 400 Hz-10 kHz
- PXIe bus provides tight synchronization and a modular, expandable platform
- Self-calibration to correct gain and offset error, and remote sense to ensure accurate excitation reference

## Modular AC LVDT, AC RVDT, Resolver, and Synchro Measurements

The PXI Displacement Input Module supports 4-, 5-, and 6-wire AC linear variable differential transformer (LVDT) and AC rotary variable differential transformer (RVDT) measurements. It simultaneously samples each analog input and sets the excitation frequency and voltage for each channel independently. You can set different timing, triggering, and sampling modes for each channel independently. Diagnostic features include self-calibration, overcurrent detection, and open coil detection. The included NI-DAQmx driver and configuration utility simplifies configuration and measurements.

Table 1. PXI Analog Input Modules provide high performance measurements on a platform built for modularity, high channel counts, and tight hardware synchronization.

	Num Ch.	Max Sample Rate	Simultaneous	Input Range	Resolution	Sensor Support	Open Coil Detection	Overcurrent Detection
PXIe-4340	4	25.6 kS/s/ch	yes	7 Vrms	24-bit	4-wire 5-wire 6-wire	yes	yes

## Detailed View of PXI Displacement Input Module

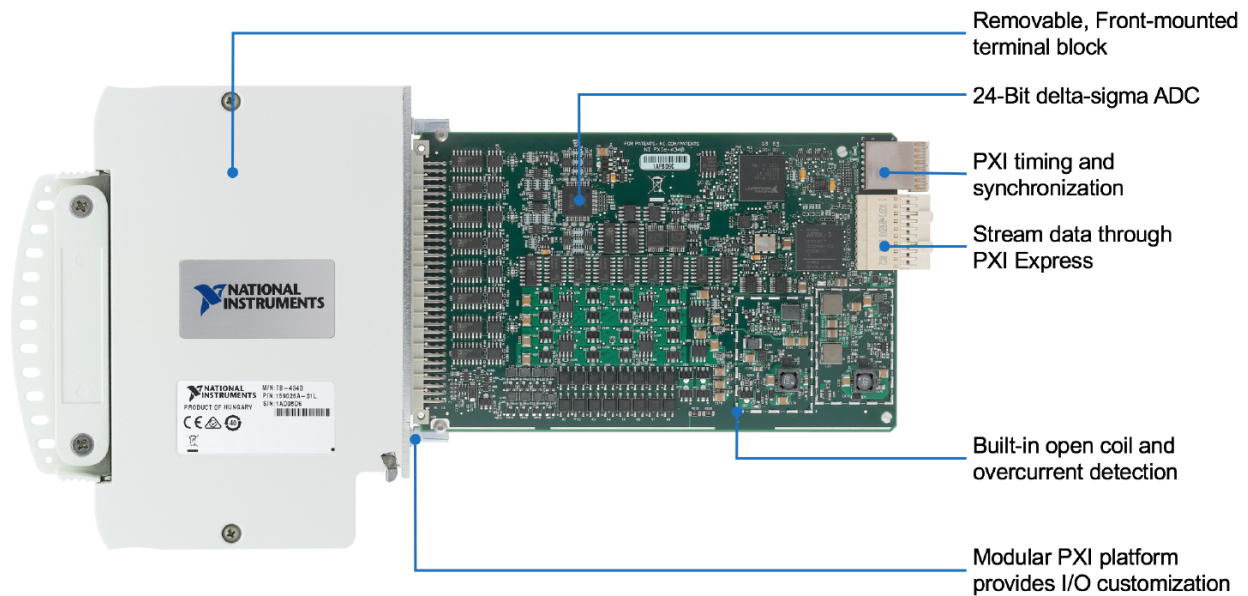

# Key Features

## High Accuracy Ratiometric Measurements

The NI PXI Displacement Input Module incorporate an analog design that removes the measurement dependence on the accuracy of the excitation voltage. The excitation voltage is continuously sensed by precision circuitry on the modules and used to drive the reference input of the ADC. Using this implementation, the module returns data as a ratio of the displacement sensor output voltage and the excitation voltage. This method continuously and automatically corrects for errors in the accuracy of the excitation voltage.

Consider how the ratiometric approach maps to the concept of displacement sensors described above. Imagine that a sensor is connected to the ADC input and excitation voltage output. Now consider an increase in the excitation voltage. The output of a displacement sensor is proportional to the excitation voltage, so if the displacement sensor is held constant, the ratio does not change. The concept of measuring a constant ratiometric output with changes in excitation is the core of the ratiometric approach.

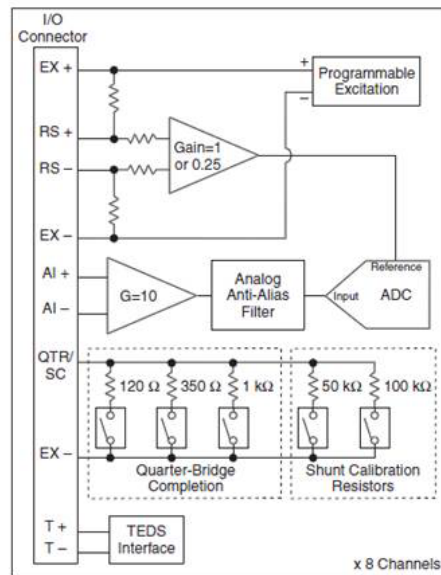

**Figure 1. The NI PXIe-433x references the excitation voltage from the ADC.**

Figure 1 shows the ratiometric measurement architecture of the NI PXIe-433x Strain/Bridge Input Modules as an example. Independent sense lines monitor the excitation output voltage and feed it into the ADC reference input. The remote sense inputs can be connected to sense the excitation voltage directly at the bridge if required to compensate for lead wire resistance desensitization errors.

## Multiple Operation Modes to Match Performance with Requirements

Buffered Mode for normal operating and high throughput applications is ideal because the module samples at the requested hardware sampling rate and efficiently returns data to the user in software. Buffered mode is optimized for measurement performance, but at the expense of higher latency due to the inherent filter delay of the delta-sigma ADC.

Hardware-Timed Single Point (HWTSP) Mode is optimized for low-latency data transfer. This allows for greater control of the rate at which data is returned to the controller. HWTSP mode is ideal when loop timing is critical, like closed-loop control and real-time applications.

Four on-board timing engines allow for different timing, triggering, and sample modes simultaneously across the same module on a per-channel basis. This allows for a diverse set of sensors without the need for additional measurement hardware.

## Guaranteed Specifications & Calibration Interval

The warranted specifications of all National Instruments data acquisition devices and modules are guaranteed to fall within the published limits for at least a year from factory calibration. Many devices and modules include a high precision on-board reference and a self-calibration feature for intermittent calibrations during use. This technology helps to correct for changes in the performance of the hardware over the normal range of operating conditions, like local changes in temperature. For guaranteed performance over time, external calibration services are provided to return a device to its “factory” performance state. This once again guarantees performance to the published specifications for an additional calibration interval of at least one year.

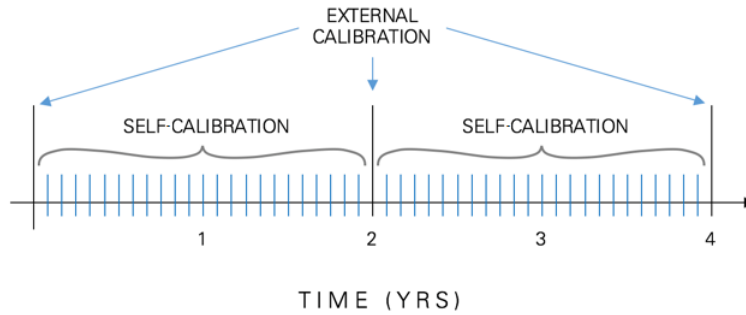

# PXI Strain/Bridge Input Module

PXIe-4330, PXIe-4331, PXIe-4339

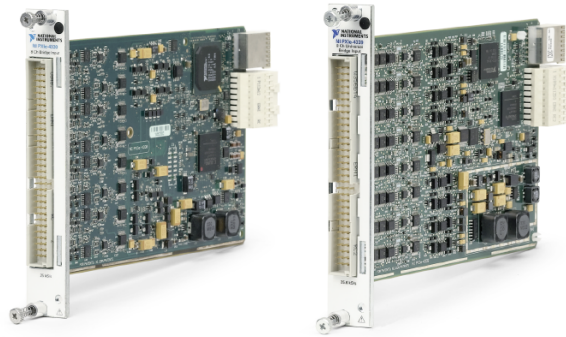

- **Software:** Includes API support for LabVIEW and text-based languages, complete with shipping examples and detailed help files.
- Voltage measurements up to 102.4 kS/s per channel at 24-bits
- Remote sense to compensate for lead wire resistance
- Per-channel excitation and bridge completion settings
- PXIe bus provides tight synchronization and a modular, expandable platform
- Anti-alias and digital filtering per channel

## Reliable Conditioning for Bridge-Based Measurements

PXI Strain/Bridge Input Modules feature up to eight channels that support quarter-, half-, or full-bridge sensors at speeds up to 102.4 kS/s. The modules provide increased accuracy, high data throughput, and a range of synchronization features. Optional features include remote sensing, internal bridge completion, and shunt calibration options per channel. PXI Strain/Bridge Input Modules are ideal for dynamic strain, load and pressure measurements, and test cell installations requiring accuracy and flexibility.

Table 1. PXI Strain/Bridge Input Modules carefully designed conditioning on a platform built for modularity, high channel counts, and tight hardware synchronization.

	Num Ch.	Max Sample Rate	Simultaneous	Input Ranges	Resolution	Bridge Excitation	Wide Bandwidth AO	Measurement Types
PXIe-4330	8	25.6 kS/s	Yes	$\pm 25$ mV $\pm 100$ mV	24 bits	$\pm 0.625$ V to $\pm 10$ V	-	Full Bridge Half Bridge Quarter Bridge
PXIe-4331	8	102.4 kS/s	Yes	$\pm 25$ mV $\pm 100$ mV	24 bits	$\pm 0.625$ V to $\pm 10$ V	-	Full Bridge Half Bridge Quarter Bridge
PXIe-4339	8	25.6 kS/s	Yes	$\pm 100$ mV $\pm 200$ mV $\pm 0.5$ V $\pm 1$ V $\pm 4$ V $\pm 10$ V $\pm 20$ mV/V $\pm 40$ mV/V $\pm 50$ mV/V $\pm 80$ mV/V $\pm 200$ mV/V $\pm 10$ mV/V $\pm$	24 bits	$\pm 0.625$ V to $\pm 10$ V	per channel	Full Bridge Half Bridge Quarter Bridge* Voltage

\*with terminal block accessory

## Detailed View of PXI Strain/Bridge Input Module

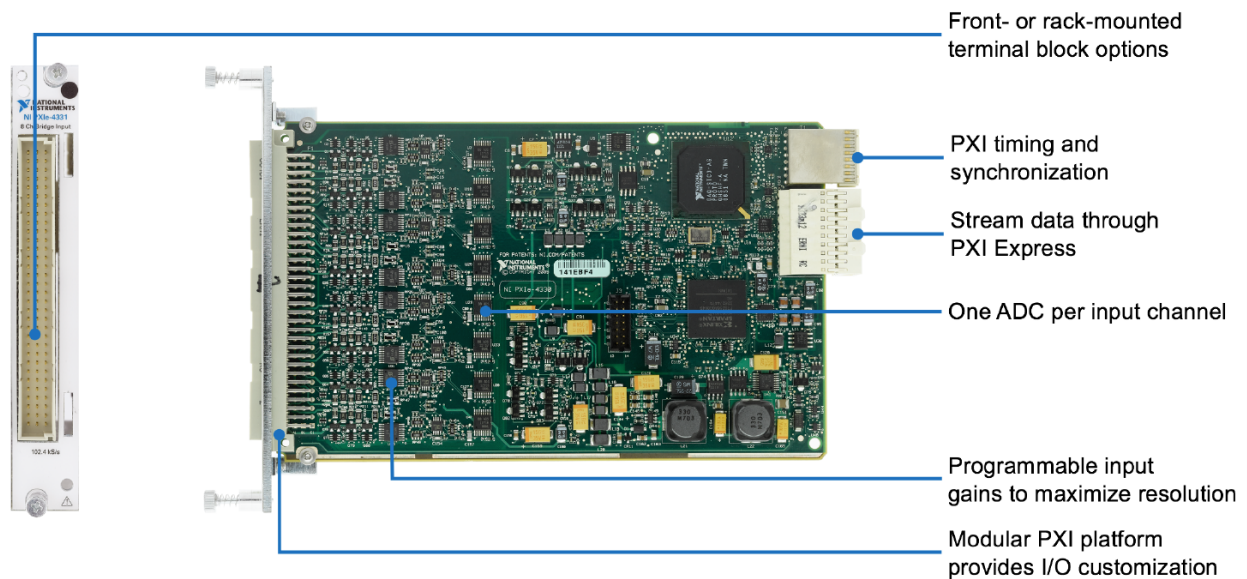

# Key Features

## High Accuracy Ratiometric Measurements

The NI PXI Strain/Bridge Input Modules incorporate an analog design that removes the measurement dependence on the accuracy of the excitation voltage. The excitation voltage is continuously sensed by precision circuitry on the modules and used to drive the reference input of the ADC. Using this implementation, the modules return data as a ratio of the bridge output voltage and the excitation voltage. This method continuously and automatically corrects for errors in the accuracy of the excitation voltage.

Consider how the ratiometric approach maps to the concept of bridge sensors described above. Imagine that a sensor is connected to the ADC input and excitation voltage output. Now consider an increase in the excitation voltage. The output of a bridge-based sensor is proportional to the excitation voltage, so if the bridge sensor is held constant, the ratio does not change. The concept of measuring a constant ratiometric output with changes in excitation is the core of the ratiometric approach.

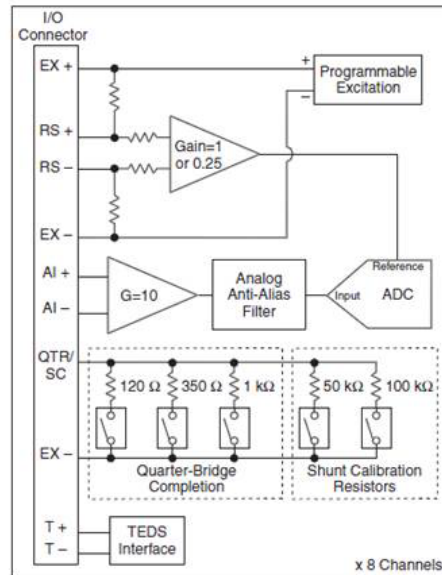

**Figure 1. The NI PXIe-433x references the excitation voltage from the ADC.**

Figure 1 shows the ratiometric measurement architecture of the NI PXIe-433x modules. Independent sense lines monitor the excitation output voltage and feed it into the ADC reference input. The remote sense inputs can be connected to sense the excitation voltage directly at the bridge if required to compensate for lead wire resistance desensitization errors.

The NI PXIe-433x bridge input modules incorporate a ratiometric hardware design optimized for bridge-based measurements; thus, the module is not well-suited for absolute voltage measurements. However, the NI PXIe-4339 has a separate voltage input mode to enable a user the flexibility of measuring strain or voltage per channel.

## Superior Alias Rejection with Anti-Alias Filtering

A digitizer or ADC might sample signals containing frequency components above the Nyquist limit. The undesirable effect of the digitizer modulating out-of-band components into the Nyquist bandwidth is aliasing. The greatest danger of aliasing is that you cannot determine if aliasing occurred by looking at the ADC output. If an input signal contains several frequency components or harmonics, some of these components might be represented correctly while others contain aliased artifacts.



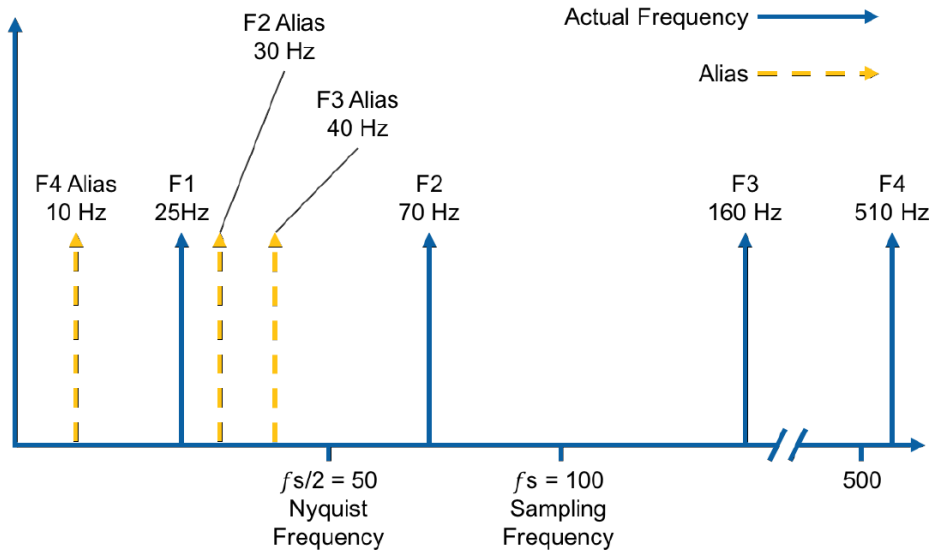

Figure 1. Frequency components above the sampling frequency appear as aliased signals in the frequency band of interest.

Lowpass filtering to eliminate components above the Nyquist frequency either before or during the digitization process can guarantee that the digitized data set is free of aliased components. In buffered mode, the modules employ both digital and analog lowpass filters to achieve this protection.

## In-Situ Calibration with PXIe-4339

In-situ calibration offers a means to determine measurement errors and uncertainties compared to a traceable standard. The RM-4339 terminal block accessory for the PXIe-4339 provides the ability to perform in-situ calibration of input channels referenced to an external traceable voltage source. The calibration data may be used to compensate for changes in the hardware, resulting in a more accurate measurement. In-situ calibration can be performed before and after test acquisition, or on a periodic schedule, to ensure data validity.



During in-situ calibration, the input channels are disconnected internally from the front-end sensor connectors and routed to a calibration bus that is driven by the external voltage reference. Any circuitry drift since the last full calibration will be measured and made available in software. In-situ calibration performs a verification but not an adjustment. Therefore, the results from in-situ calibration will not rewrite the calibration coefficients to the PXIe-4339, instead these results can be applied to the test setup, test results or to the PXIe-4339 in software.

## Guaranteed Specifications & Calibration Interval

The warranted specifications of all National Instruments data acquisition devices and modules are guaranteed to fall within the published limits for at least a year from factory calibration. Many devices and modules include a high precision on-board reference and a self-calibration feature for intermittent calibrations during use. This technology helps to correct for changes in the performance of the hardware over the normal range of operating conditions, like local changes in temperature. For guaranteed performance over time, external calibration services are provided to return a device to its “factory” performance state. This once again guarantees performance to the published specifications for an additional calibration interval of at least one year.

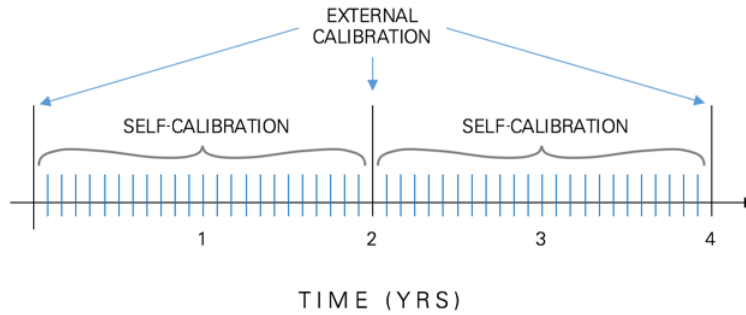

# PXI Temperature Input Module

PXIe-4353, PXIe-4357

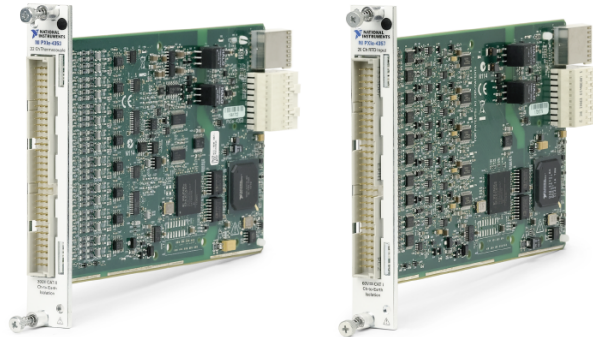

- **Software:** Includes API support for LabVIEW and text-based languages, complete with shipping examples and detailed help files.
- Thermocouple and RTD measurements up to 100 S/s per channel at 24-bits
- 300 Vrms CAT II bus or 60VDC CAT I bank isolation
- Isothermal terminal blocks with embedded CJC channels
- Internal autozero channels for offset error compensation
- PXIe bus provides tight synchronization and a modular, expandable platform
- Open thermocouple detection per channel

## High Density Modules for Conditioned Temperature Measurements

PXI Temperature Input Modules offer up to 32 channels of analog temperature measurements. Some models include autozero channels for offset compensation as well as open thermocouple detection to identify disconnected thermocouples, while others support 2-, 3-, or 4-wire resistance temperature detector (RTD) measurements. PXI Temperature Input Modules support both high-speed and high-resolution modes. You can program channel configurations and scale measured data into engineering units.

Table 1. PXI Analog Input Modules provide high performance measurements on a platform built for modularity, high channel counts, and tight hardware synchronization.

	Num Ch.	Max Sample Rate	Input Range	Resolution	Sensor Support	Accuracy*	Features
PXIe-4353	32	90 S/s	±80mV	24-bit	Thermocouple	0.3°C	Open Thermocouple Detection Autozero Cold Junction Compensation High Speed Mode High Accuracy Mode
PXIe-4357	20	100 S/s	-200°C to 850°C	24-bit	2-, 3-, 4-wire PT100 RTD	0.09°C	High Speed Mode High Accuracy Mode

\*Accuracy specifications are typical for type J thermocouples at 23°C±5°C, and does not account for losses due to cables, sensors, etc.

## Detailed Views of PXI Temperature Input Module

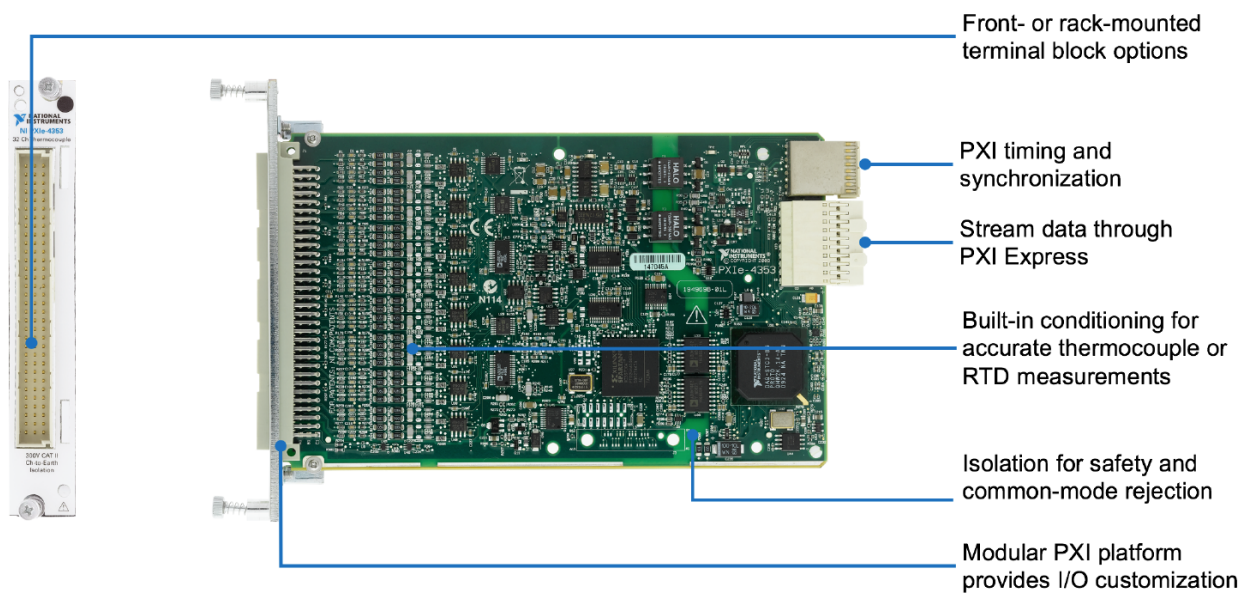

# Key Features

## High Resolution, High Accuracy Temperature Measurements

The key to ensuring high-quality temperature measurements is measurement hardware with sufficiently good resolution and appropriate signal conditioning. The PXI Temperature Input Modules from National Instruments offer both of these features in one compact, modular form factor. A meticulously designed analog front end provides 24-bit analog to digital conversion in a signal path tuned to provide accuracy to a fraction of a degree.

## Isothermal Terminal Block with Cold Junction Compensation

The NI PXIe-4353 thermocouple module can measure temperatures with  $.30\text{ }^{\circ}\text{C}$  typical accuracy and 24-bit resolution on 32 channels. The NI TB-4353 isothermal terminal block, which provides powerful cold-junction compensation (CJC), achieves the high-accuracy levels. CJC improves your measurement accuracy by providing the temperature at the cold junctions and applying the appropriate correction. The isothermal terminal block minimizes error with a unique design that optimizes thermal conductivity, making it possible for the nearby CJC thermistors to accurately measure the temperature at the thermocouple junctions. The TB-4353 front-mounting terminal block includes eight CJC thermistors that are distributed on the terminal block to closely measure the cold junctions across the terminal block.

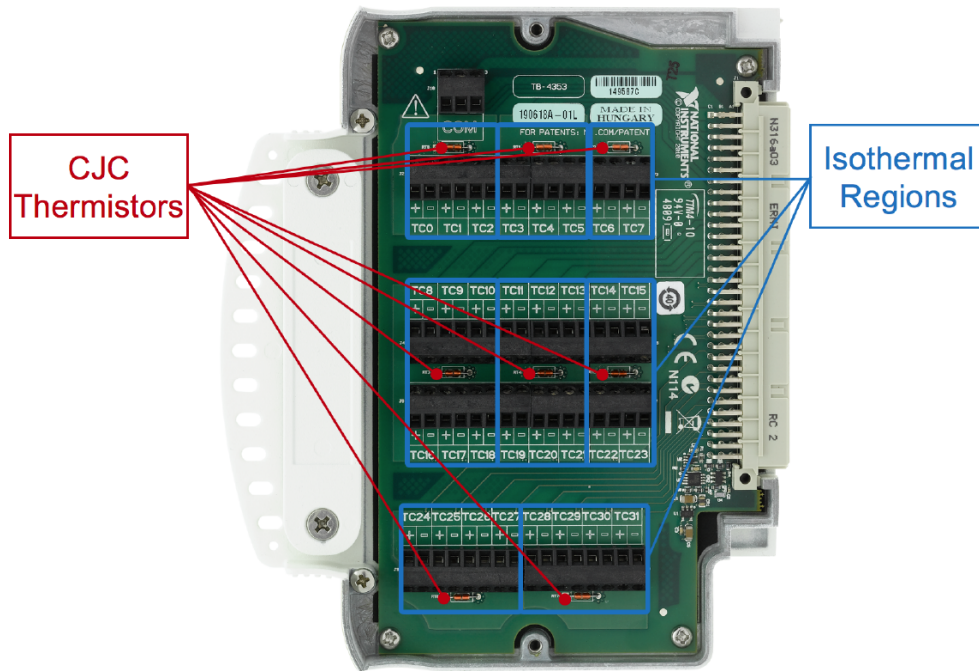

## Guaranteed Specifications & Calibration Interval

The warranted specifications of all National Instruments data acquisition devices and modules are guaranteed to fall within the published limits for at least a year from factory calibration. Many devices and modules include a high precision on-board reference and a self-calibration feature for intermittent calibrations during use. This technology helps to correct for changes in the performance of the hardware over the normal range of operating conditions, like local changes in temperature. For guaranteed performance over time, external calibration services are provided to return a device to its “factory” performance state. This once again guarantees performance to the published specifications for an additional calibration interval of at least one year.

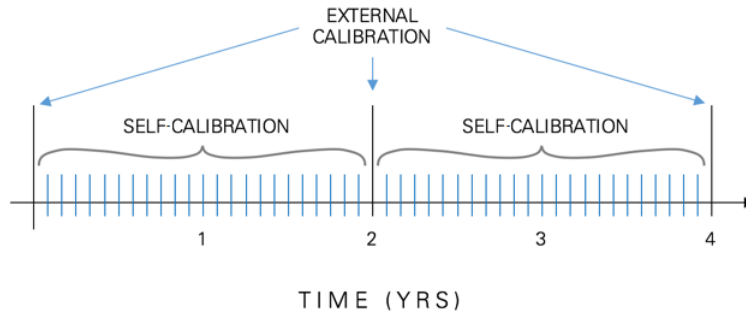

# NI-DAQmx Driver and Application Programming Interface (API)

The [NI-DAQmx driver](#) includes a best-in-class API that works directly with a variety of development options including LabVIEW, DAQExpress, C, C#, Python, and others. The native integration provides exceptional performance and a seamless experience without the need for manual wrapping of functions. To ensure long-term interoperability of DAQ devices, the NI-DAQmx driver API is the same API used for all NI DAQ products – meaning re-development efforts can be minimized regardless of hardware changes or upgrades. Additionally, the driver provides access to help files, documentation, and dozens of ready-to-run shipping examples you can use as a starting point for your application.

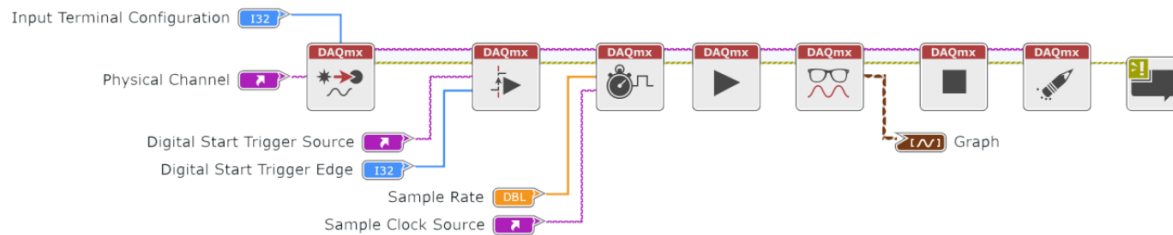

# Platform-Based Approach to Test and Measurement



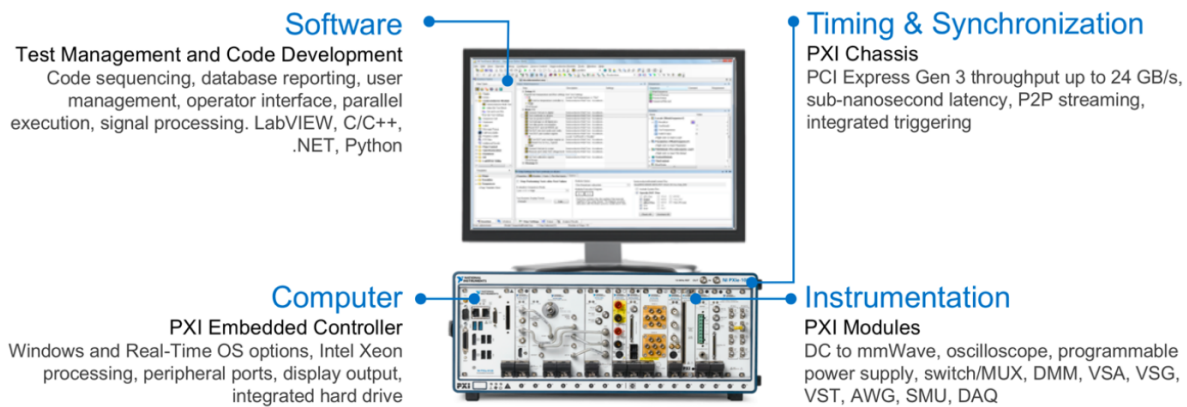

## What Is PXI?

Powered by software, PXI is a rugged PC-based platform for measurement and automation systems. PXI combines PCI electrical-bus features with the modular, Eurocard packaging of CompactPCI and then adds specialized synchronization buses and key software features. PXI is both a high-performance and low-cost deployment platform for applications such as manufacturing test, military and aerospace, machine monitoring, automotive, and industrial test. Developed in 1997 and launched in 1998, PXI is an open industry standard governed by the PXI Systems Alliance (PXISA), a group of more than 70 companies chartered to promote the PXI standard, ensure interoperability, and maintain the PXI specification.



## Integrating the Latest Commercial Technology

By leveraging the latest commercial technology for our products, we can continually deliver high-performance and high-quality products to our users at a competitive price. The latest PCI Express Gen 3 switches deliver higher data throughput, the latest Intel multicore processors facilitate faster and more efficient parallel (multisite) testing, the latest FPGAs from Xilinx help to push signal processing algorithms to the edge to accelerate measurements, and the latest data converters from TI and ADI continually increase the measurement range and performance of our instrumentation.

<p>HIGHER DATA THROUGHPUT</p>  <p>PCI Express Gen 3</p>	<p>PARALLEL TEST EXECUTION</p>  <p>Multicore Processors</p>	<p>MEASUREMENT ACCELERATION</p>  <p>FPGAs</p>	<p>INCREASED MEASUREMENT RANGE</p>  <p>Data Converters</p>
--	--	---	---



# Hardware Services

All NI hardware includes a one-year warranty for basic repair coverage, and calibration in adherence to NI specifications prior to shipment. PXI systems also include basic assembly and a functional test. NI offers additional entitlements to improve uptime and lower maintenance costs with service programs for hardware. Learn more at [ni.com/services/hardware](http://ni.com/services/hardware).

	Standard	Premium	Description
Program Duration	1, 3, or 5 years	1, 3, or 5 years	Length of service program
Extended Repair Coverage	•	•	NI restores your device's functionality and includes firmware updates and factory calibration.
System Configuration, Assembly, and Test <sup>1</sup>	•	•	NI technicians assemble, install software in, and test your system per your custom configuration prior to shipment.
Advanced Replacement <sup>2</sup>		•	NI stocks replacement hardware that can be shipped immediately if a repair is needed.
System Return Material Authorization (RMA) <sup>1</sup>		•	NI accepts the delivery of fully assembled systems when performing repair services.
Calibration Plan (Optional)	Standard	Expedited <sup>3</sup>	NI performs the requested level of calibration at the specified calibration interval for the duration of the service program.

<sup>1</sup>This option is only available for PXI, CompactRIO, and CompactDAQ systems.

<sup>2</sup>This option is not available for all products in all countries. Contact your local NI sales engineer to confirm availability.

<sup>3</sup>Expedited calibration only includes traceable levels.

## PremiumPlus Service Program

NI can customize the offerings listed above, or offer additional entitlements such as on-site calibration, custom sparring, and life-cycle services through a PremiumPlus Service Program. Contact your NI sales representative to learn more.

## Technical Support

Every NI system includes a 30-day trial for phone and e-mail support from NI engineers, which can be extended through a [Software Service Program \(SSP\)](#) membership. NI has more than 400 support engineers available around the globe to provide local support in more than 30 languages. Additionally, take advantage of NI's award winning [online resources](#) and [communities](#).

©2017 National Instruments. All rights reserved. LabVIEW, National Instruments, NI, NI TestStand, and ni.com are trademarks of National Instruments. Other product and company names listed are trademarks or trade names of their respective companies. The contents of this Site could contain technical inaccuracies, typographical errors or out-of-date information. Information may be updated or changed at any time, without notice. Visit [ni.com/manuals](http://ni.com/manuals) for the latest information.

11 March 2020